

Colossians 2:16-23

Literal Translation
Greek/English Interlinear
Overall Diagram

Colossians 2:1-23

Literal English Translation

Colossians Chapters 1-2

The Doctrine of Completeness in Christ

Colossians 2:1-5

The Pain of Paul

1) For I want you to know how great a conflict I have concerning you, and the ones in Laodicea, and as many as have not seen my face in *the* flesh,

2) in order that their hearts might be comforted, having been joined together in agape, and toward all wealth of the full-assurance of the understanding, toward *the* full-knowledge of the mystery of God, and [of *the* Father and] of Christ,

3) in whom are hidden all the treasures of wisdom and of knowledge.

4) And I say this in order that no one might deceive you in persuasive speech.

5) For if I am indeed absent in the flesh, but I am with you in spirit, rejoicing and seeing your order and the firmness of your faith toward Christ.

Colossians 2:6-7

The Precepts of Paul

6) Therefore, as you received Christ Jesus the Lord, be continually walking in Him,

7) having been rooted and being built up in Him, and being established in the faith, according as you were taught, abounding in it in thanksgiving.

Colossians 2:1-23

Literal English Translation

Colossians 2:8-15

The Precaution of Paul

8) Be watching *that* not anyone will be leading you captive through philosophy and empty deceit, according to the tradition of men, according to the elements of the world, and not according to Christ.

9) For in Him is dwelling all the fullness of the Godhead bodily;

10) and you are complete in Him,
Who is the Head of all rule and authority,

11) in whom also you were circumcised *with a* circumcision not made by hand, in the putting off of the body of the sins of the flesh, in the circumcision of Christ,

12) having been buried together with Him in baptism, in which also you were raised through the faith of the energy of God, the One who has raised Him from out of the dead.

13) And you, being dead in the trespasses and the uncircumcision of your flesh, He made alive together with Him, having forgiven all your trespasses,

14) having wiped away the handwriting *in* the decrees against us, which was contrary to us, and He has removed it out of the midst, having nailed it to the cross;

15) having stripped the rulers and the authorities, He made a show in openness, having led them in triumph in it.

Colossians 2:1-23

Literal English Translation

Colossians 2:16-19

The Protection of Paul

16) Let not anyone therefore judge you
in food, or in drink,
or in respect of a feast
or of a new moon,
or of Sabbaths:

17) Which are *a* shadow of the coming things;
but the body *is* of Christ.

18) Let not even one rule against you,
while being willing in humble-mindedness
and worship of angels,
inquiring in what things he has [not] seen,
being vainly puffed up by the mind of his flesh,

19) and not holding the Head,
from out of which all the body
through the joints and ligaments
being supplied and being joined together
is growing *with* the growth of God.

Colossians 2:20-23

The Plea of Paul

20) Therefore if you died with Christ
from the elements of the world,
why, as living in *the* world,
are you subjecting yourselves to decrees,

21) you should not hold;
you should not taste,
you should not touch;

22) which all are for corruption *in* the using;
according to the commandments and teachings
of men?

23) which things are having indeed *an* expression
of wisdom in will-worship and humble-mindedness
and without sparing of *the* body;
not in any honor to *the* satisfying of the flesh.

Colossians 2:16-23
Greek / English Interlinear

- 16) **Μὴ οὖν τις ὑμᾶς κρινέτω ἐν βρώσει ἢ (καὶ) ἐν πόσει,**
Not therefore anyone you let judge in food or (and) in drink,
ἢ ἐν μέρει ἑορτῆς ἢ νομηνίας (νεομηνίας) ἢ σαββάτων·
or in respect of feast or of new moon (of new moon) or of Sabbaths;
- 17) **ἃ ἐστι(ν) σκιά τῶν μελλόντων, τὸ δὲ σῶμα τοῦ**
which things is shadow the of coming things, the but body the
Χριστοῦ.
of Christ.
- 18) **μηδεὶς ὑμᾶς καταβραβευέτω θέλων ἐν ταπεινοφροσύνῃ καὶ**
not even one you let rule against being willing in humble-mindedness and
θρησκείᾳ τῶν ἀγγέλων, ἃ [μὴ] ἑώρακεν (ἑώρακεν)
worship the of angels, which things [not] he has seen (he has seen)
ἐμβατεύων, εἰκῆ φυσιούμενος ὑπὸ τοῦ νοῦς τῆς σαρκὸς αὐτοῦ,
inquiring in, vainly being puffed up by the mind the of flesh of him,
- 19) **καὶ οὐ κρατῶν τὴν κεφαλὴν, ἐξ οὗ πᾶν τὸ σῶμα, διὰ**
and not holding firm the head, out of whom all the body, through
τῶν ἀφῶν καὶ συνδέσμων ἐπιχορηγούμενον καὶ συμβιβαζόμενον,
the joints and bands being supplied and being joined together,
αὐξει τὴν αὐξησιν τοῦ Θεοῦ.
is growing the growth the of God.
- 20) **Εἰ [οὖν] ἀπεθάνετε σὺν [τῷ] Χριστῷ ἀπὸ τῶν στοιχείων τοῦ**
If [therefore] you died with [the] Christ from the elements the
κόσμου, τί, ὡς ζῶντες ἐν κόσμῳ, δογματίζεσθε,
of world, why, as living in world, are you subjecting yourselves to decrees,
- 21) **Μὴ ἄψη, μηδὲ γεύση, μηδὲ θίγης,**
Not you should hold, neither you should taste, nor should you touch,

Colossians 2:16-23

Greek / English Interlinear (continued)

22) ἅ ἐστι(ν) πάντα εἰς φθοράν τῇ ἀποχρήσει, κατὰ τὰ
what things is all things for corruption the using, according to the

ἐντάλματα καὶ διδασκαλίας τῶν ἀνθρώπων;
commandments and teachings the of men?

23) ἅτινα ἐστι(ν) λόγον μὲν ἔχοντα σοφίας ἐν ἐθελοθησκείᾳ
which things is expression indeed having of wisdom in will-worship

(ἐθελοθησκείᾳ) καὶ ταπεινοφροσύνη καὶ ἀφειδία σώματος,
(will-worship) and humble-mindedness and without sparing of body,

οὐκ ἐν τιμῇ τινι πρὸς πλησμονὴν τῆς σαρκός.
not in honor any for satisfying the of flesh.

Colossians 2:16-23

Diagram

16)

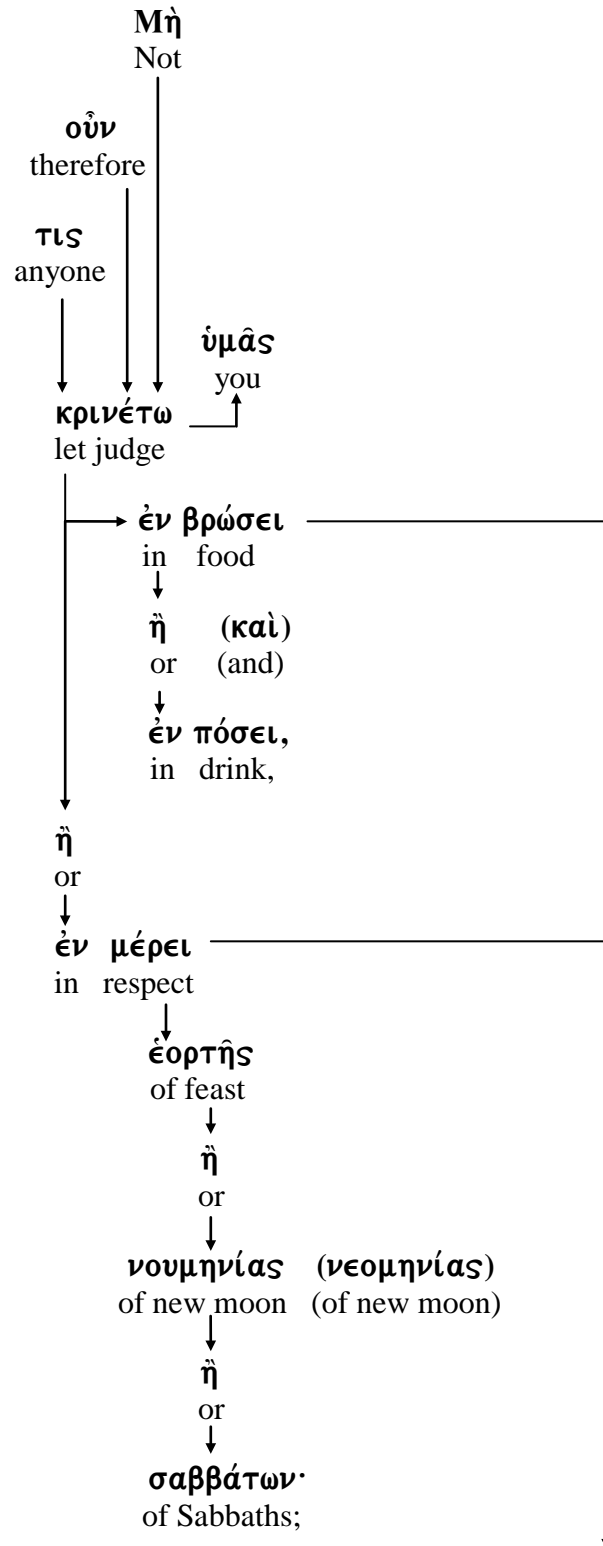

Colossians 2:16-23
Diagram (continued)

17)

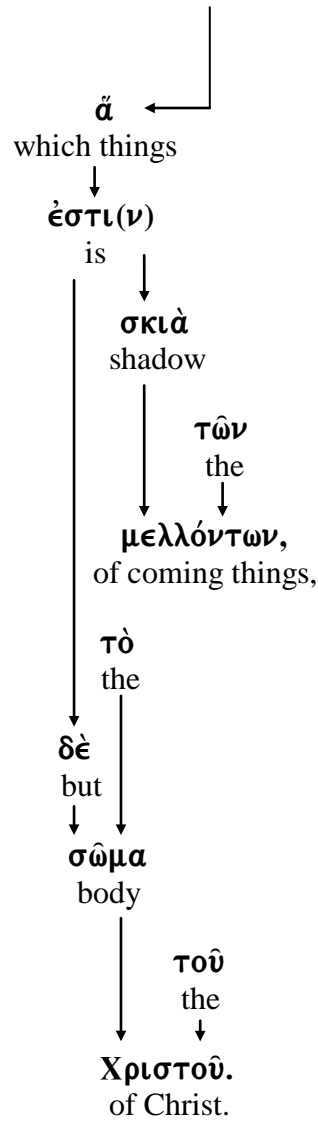

Colossians 2:16-23
Diagram (continued)

18)

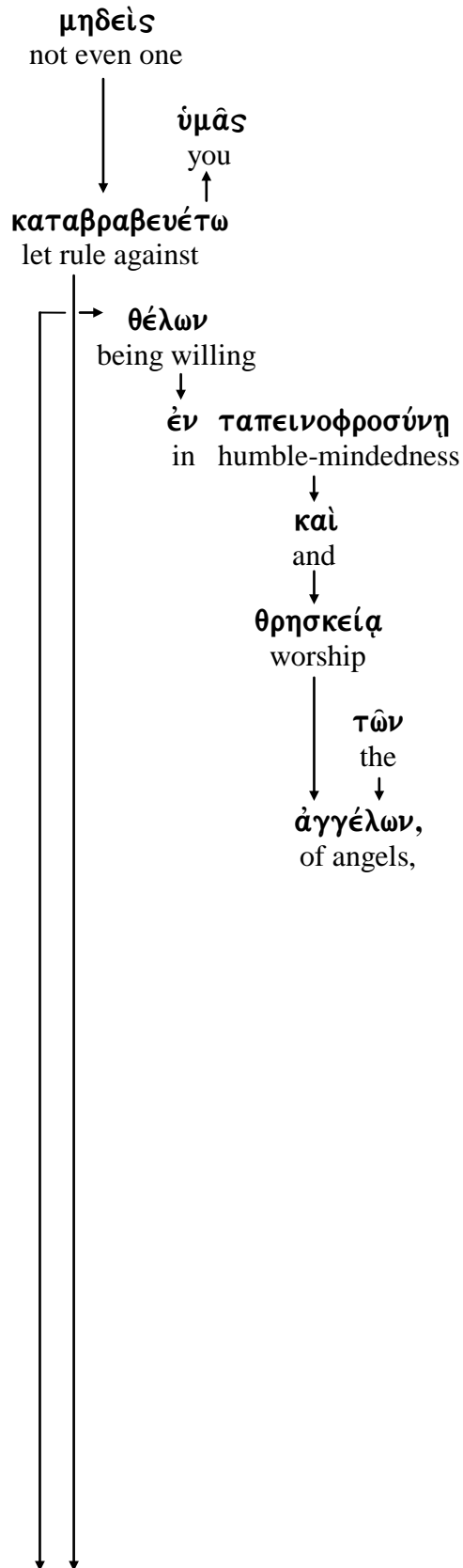

Colossians 2:16-23
 Diagram (continued)

18) cont.

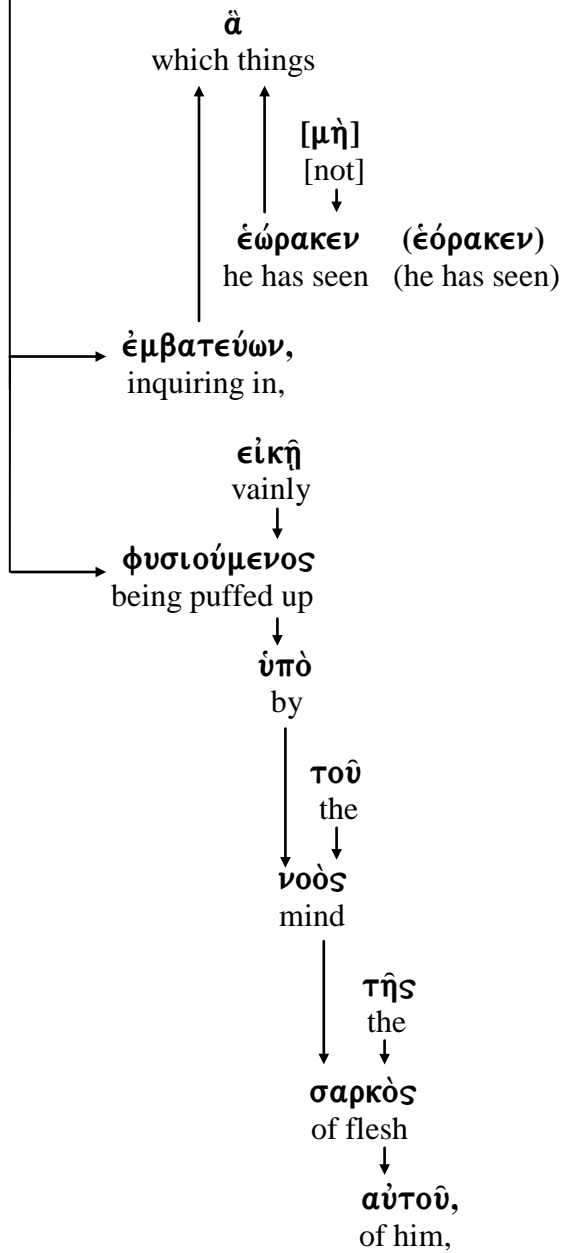

Colossians 2:16-23
Diagram (continued)

19)

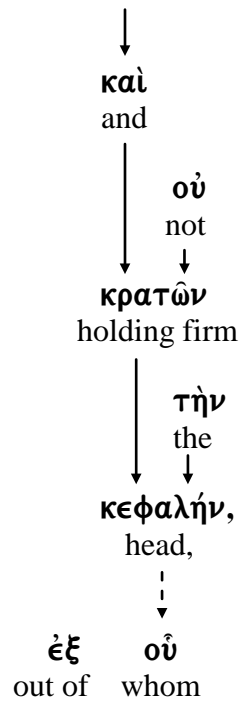

Colossians 2:16-23
Diagram (continued)

19) cont.

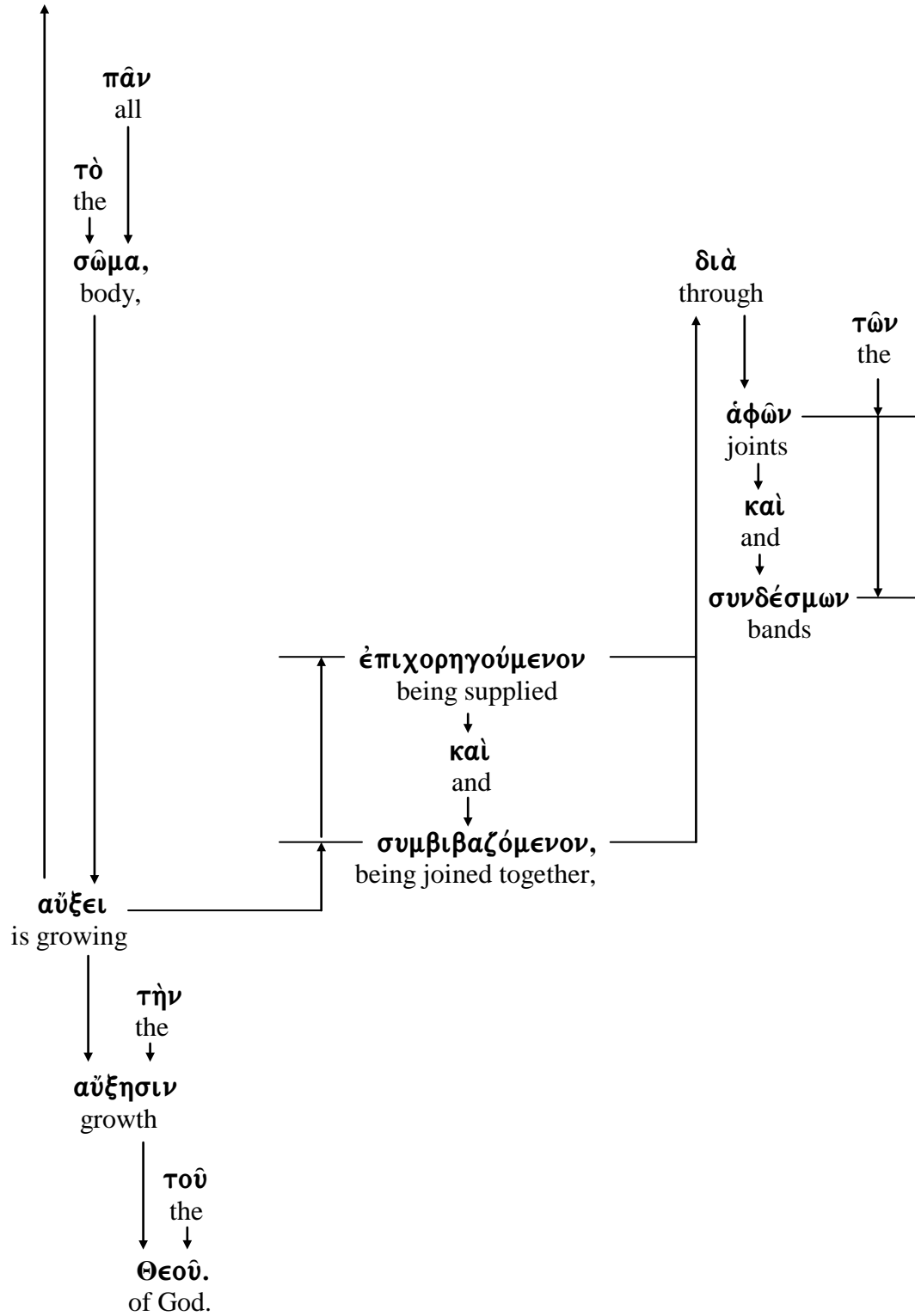

Colossians 2:16-23
Diagram (continued)

20)

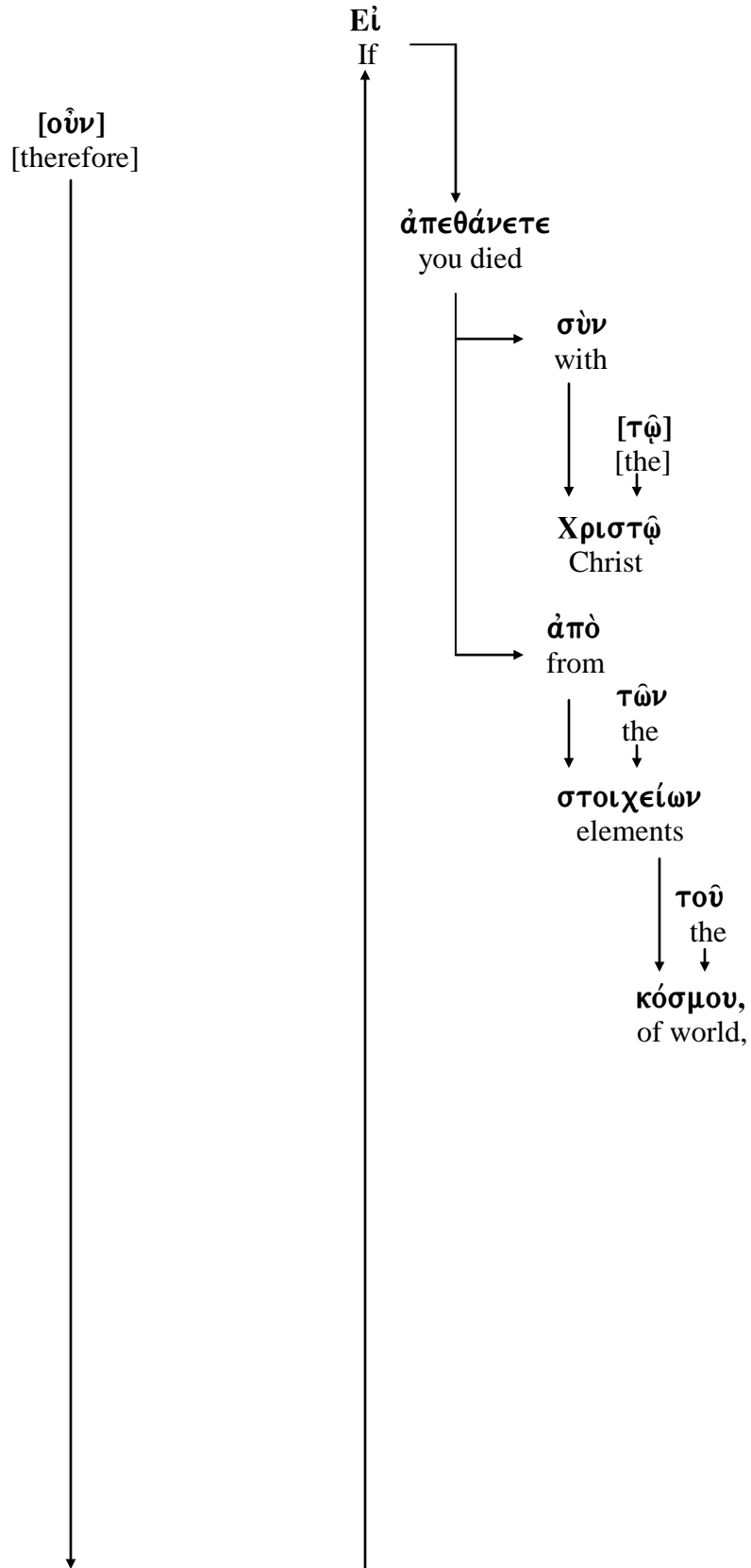

Colossians 2:16-23

Diagram (continued)

20) cont.

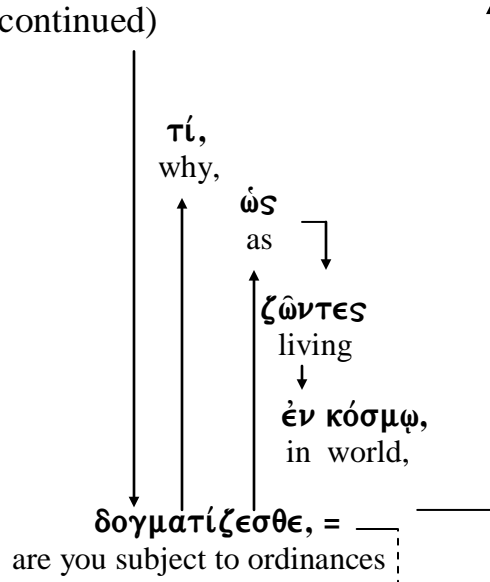

21)

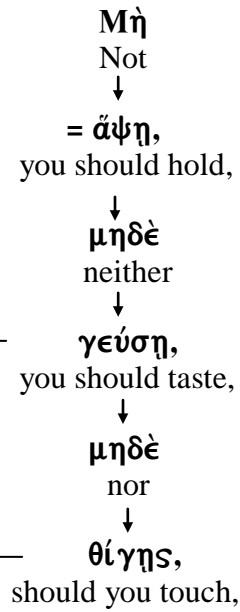

Colossians 2:16-23
Diagram (continued)

22)

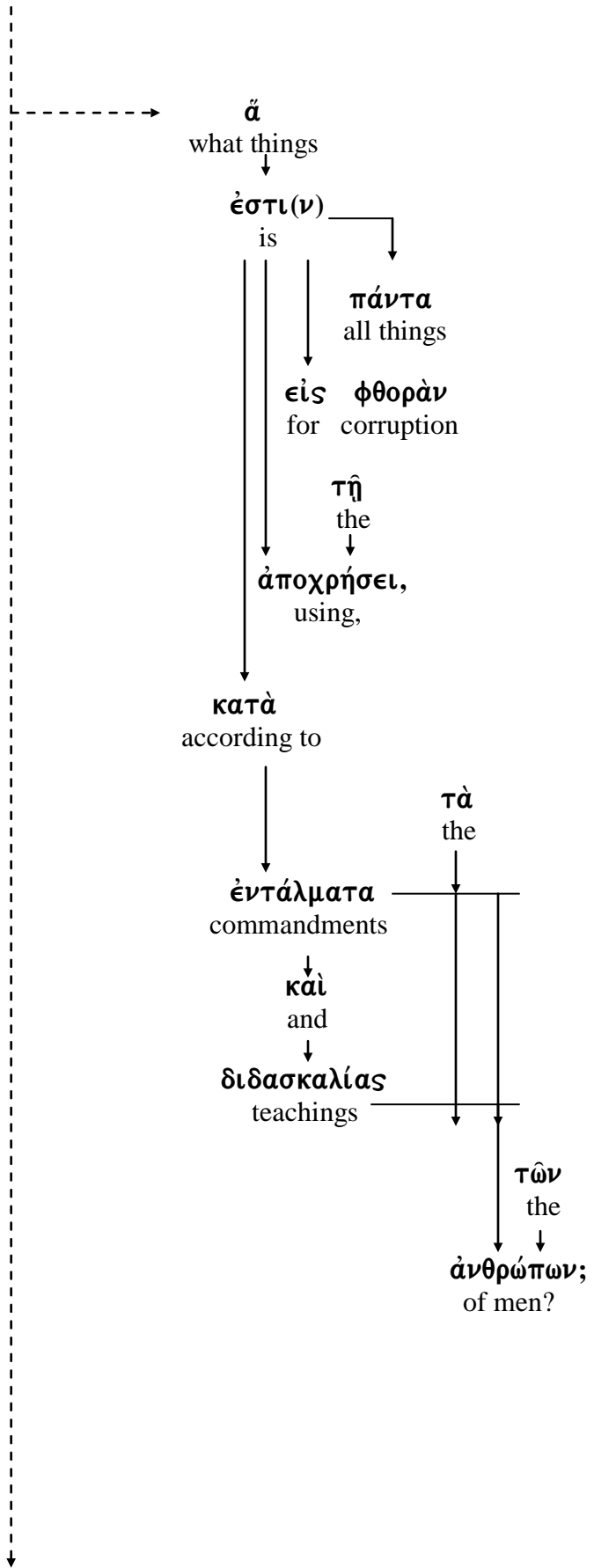

Colossians 2:16-23
Diagram (continued)

23)

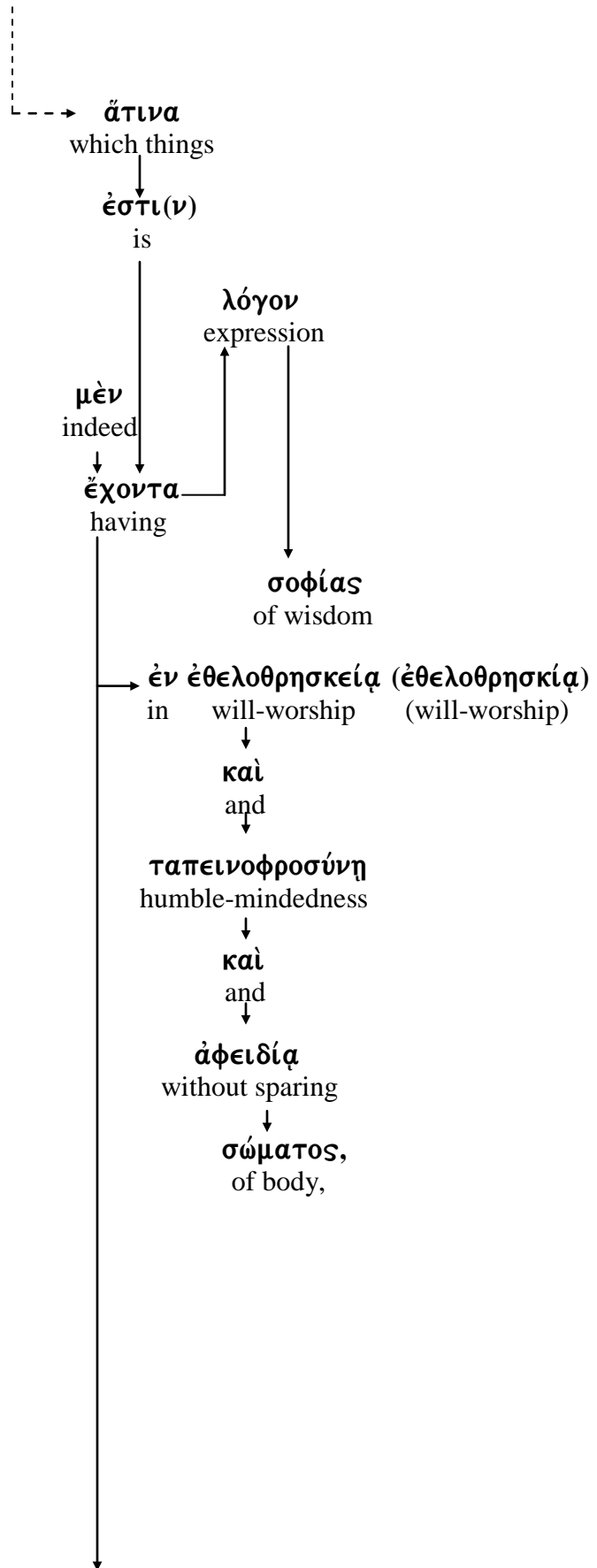

Colossians 2:16-23
Diagram (continued)

23) cont.

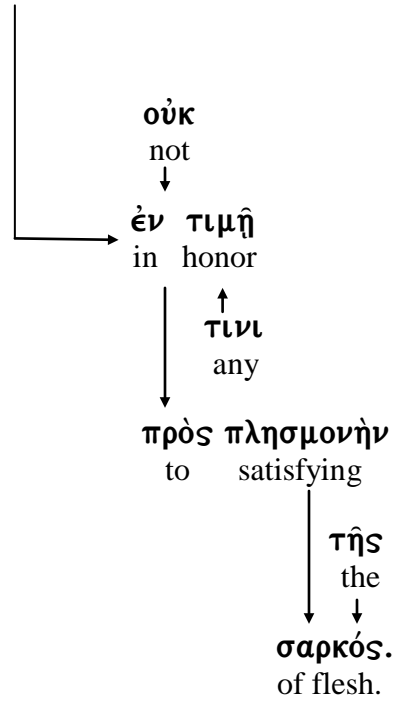

Genesis 2:1-3

Hebrews 4

Literal Translation

Colossians 2:16

Supplemental Scriptures

Genesis 2:1-3 LET

1) And the heavens and the earth were finished, and all the host of them.

2) And in the seventh day God finished His work which He had made, and He rested in the seventh day from all His work which He had made.

3) And God blessed the seventh day and sanctified it, because in it He had rested from all His work which God had created to make.

Hebrews 4 LET

1) ¶ We should therefore fear, *that* not at anytime *a* promise being left *us* to enter into His rest, anyone from you should seem to have come short *of it*.

2) For, indeed, we are *the ones* having had the gospel preached *to us*, according as also those; but the Word of hearing did not profit those, *it* not having been mixed *with* faith to the ones having heard *it*.

3) For we, the ones having believed, are entering into the rest, according as He has said, “As I swore in My wrath, if they shall enter into My rest,” even though the works have been done from *the* foundation of the world.

4) For He has said somewhere concerning the seventh *day* in this way, “And God rested in the seventh day from all His works.”

Colossians 2:16

Supplemental Scriptures

5) And in this *place* again,
“If they shall enter into My rest.”

6) Since therefore it is remaining *for* some
to enter into it,
and the ones who first had been preached to
did not enter in on account of disobedience,

7) again He marks out *a* certain day,
in David saying, "Today"
after so long *a* time,
according as it has been said,
“Today, if you should hear His voice,
you should not harden your hearts.”

8) For if Joshua gave them rest,
He would not after these things
have spoken concerning another day.

9) There is remaining then *a* Sabbath rest
for the people of God.

10) For the one who has entered into His rest,
he himself also ceased from his *own* works,
as indeed God *did* from His own.

11) We should be diligent therefore
to enter into that rest,
in order that not anyone should fall
in the same example of the disobedience.

12) For the Word of God *is* living,
and energizing,
and sharper beyond any two-edged sword,
and piercing as far as *the* division
of both soul and spirit,
and of joints and marrows,
and *is a* discerner
of *the* thoughts and motivations of *the* heart;

13) and there is not *a* creature
hidden before Him; but all things
are naked and have been opened
to the eyes of Him, with whom for us *to give*
account.

Colossians 2:16

Supplemental Scriptures

14) Having therefore *a* great High Priest *who has* passed through the heavens, Jesus the Son of God, we should hold firm the confession.

15) For we do not have *a* high priest not being able to sympathize with our weaknesses, but according to all things has been tempted according to *our* likeness, without sin.

16) We should therefore come with confidence to the throne of grace, in order that we might receive mercy, and we might find grace for timely help.