

# Lesson Nine

Colossians 2:16-19

## Colossians 2:16-19

### Greek Text

16) Μὴ οὖν τις ὑμᾶς κρινέτω ἐν βρώσει ἢ (καὶ) ἐν πόσει, ἢ  
Not therefore anyone you let judge in food or (and) in drink, or

ἐν μέρει ἑορτῆς ἢ νομηνίας (νεομηνίας) ἢ σαββάτων·  
in respect of feast or of new moon (of new moon) or of sabbaths;

17) ἃ ἐστι(ν) σκιά τῶν μελλόντων, τὸ δὲ σῶμα τοῦ  
which things is shadow the of coming things, the but body the

Χριστοῦ.  
of Christ.

18) μηδεὶς ὑμᾶς καταβραβεύτω θέλων ἐν ταπεινοφροσύνῃ καὶ  
not even one you let cheat of prize desiring in humble-mindedness and

θρησκείᾳ τῶν ἀγγέλων, ἃ [μὴ] ἑώρακεν (ἑώρακεν)  
worship the of angels, which things [not] he has seen (he has seen)

ἐμβατεύων, εἰκῆ φυσιούμενος ὑπὸ τοῦ νοῦς τῆς σαρκὸς αὐτοῦ,  
inquiring in, vainly being puffed up by the mind the of flesh of him,

19) καὶ οὐ κρατῶν τὴν κεφαλὴν, ἐξ οὗ πᾶν τὸ σῶμα, διὰ τῶν  
and not holding the head, out of which every the body, through the

ἄφῶν καὶ συνδέσμων ἐπιχορηγούμενον καὶ συμβιβαζόμενον, αὖξει  
joints and bands being supplied and being joined together, is growing

τὴν αὐξησιν τοῦ Θεοῦ.  
the growth the of God.

## Lesson Nine

### Colossians 2:16-19 Greek Text

#### Page 296

**Colossians 2:16-19**  
**Overall Diagram**

16)

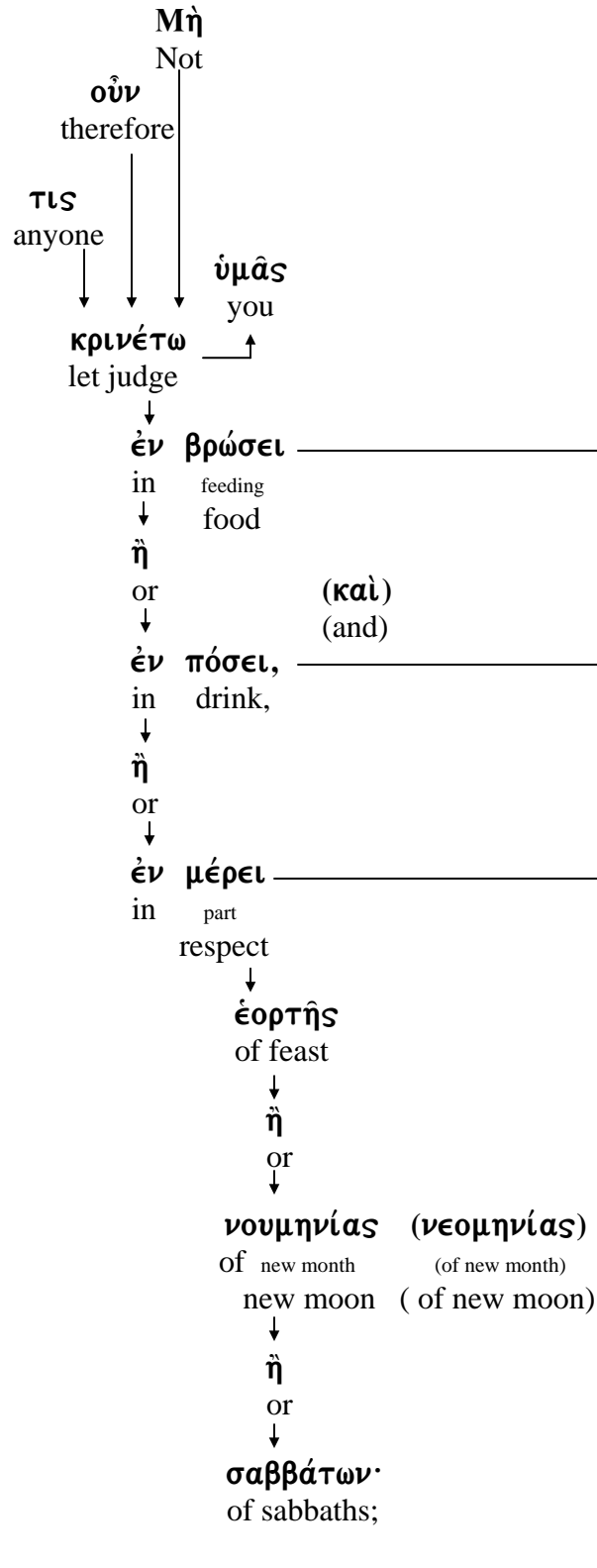

**Colossians 2:16-19**  
**Overall Diagram (continued)**

17)

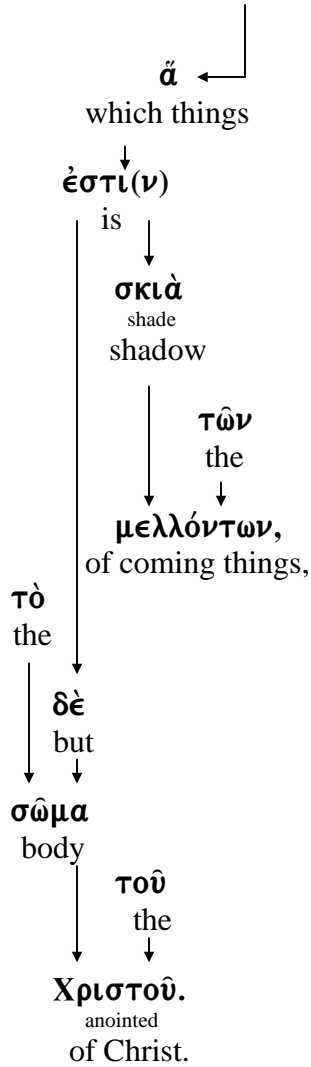



**Colossians 2:16-19**  
**Overall Diagram (continued)**

18) cont.

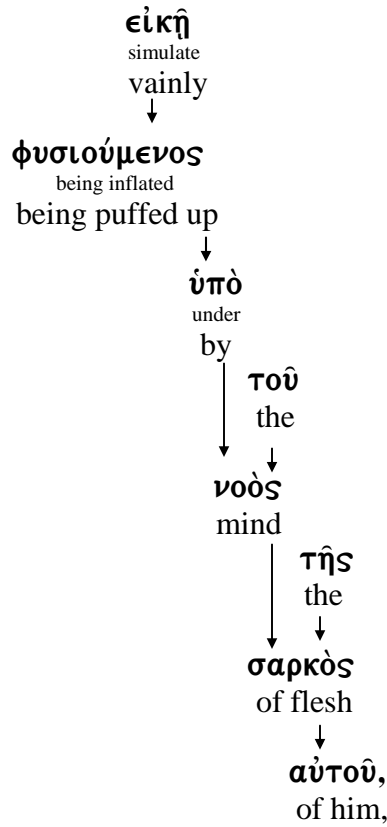

19)

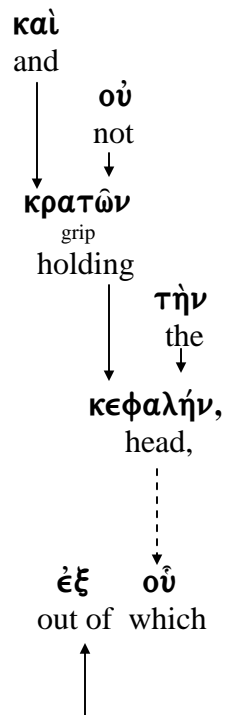

**Lesson Nine**  
**Colossians 2:16-19 Overall Diagram**  
**Page 300**

**Colossians 2:16-19**  
**Overall Diagram (continued)**

19) cont.

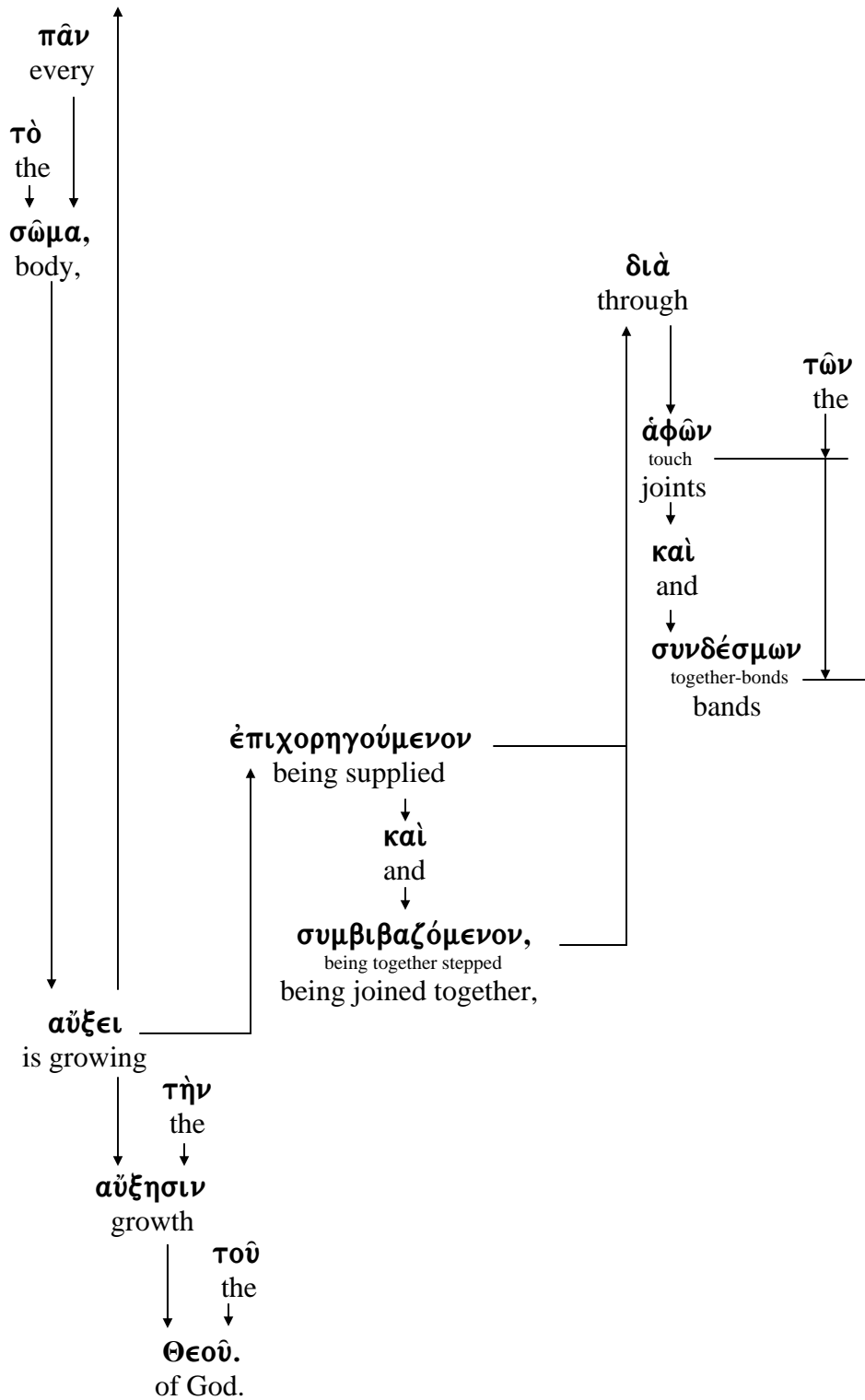



**Colossians 2:16-19**  
**Word Association Diagram (continued)**

18) cont.

↓ τῆς  
 σαρκὸς  
 αὐτοῦ,

19)

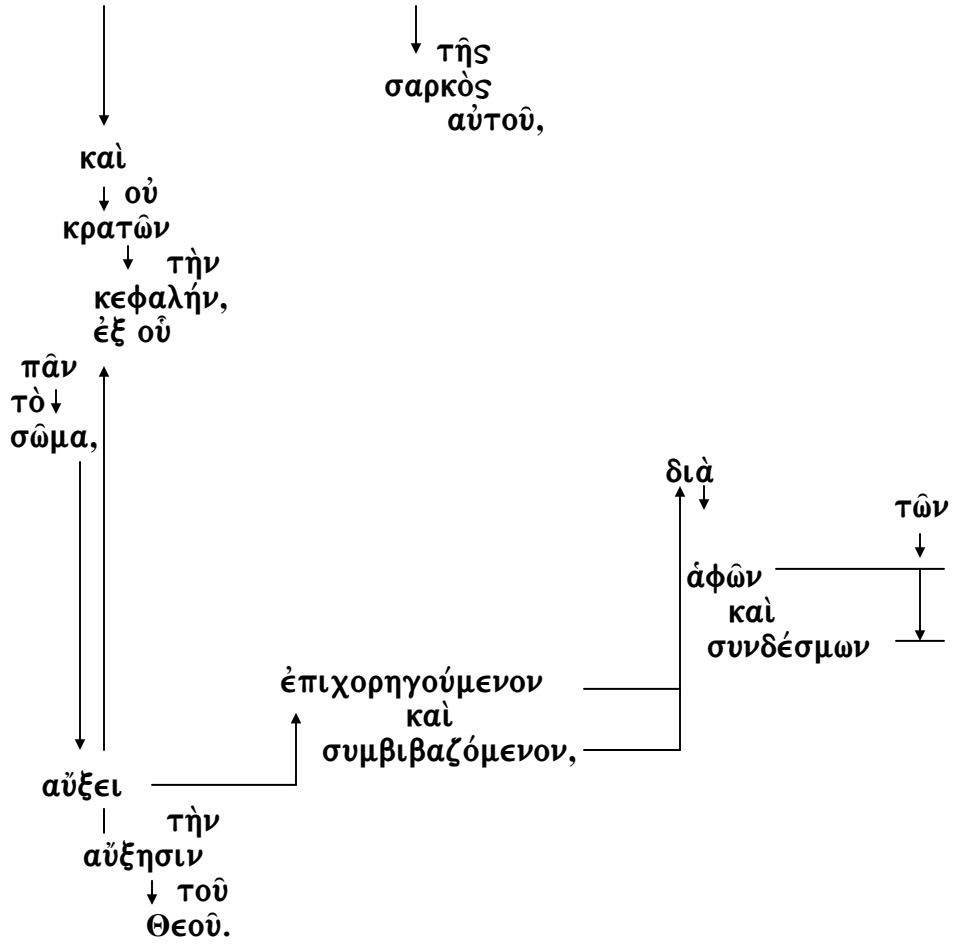



# Lesson Nine

## Colossians 2:16-19

### Diagrams

**Colossians 2:16-19**  
**Verse 16 Diagram**

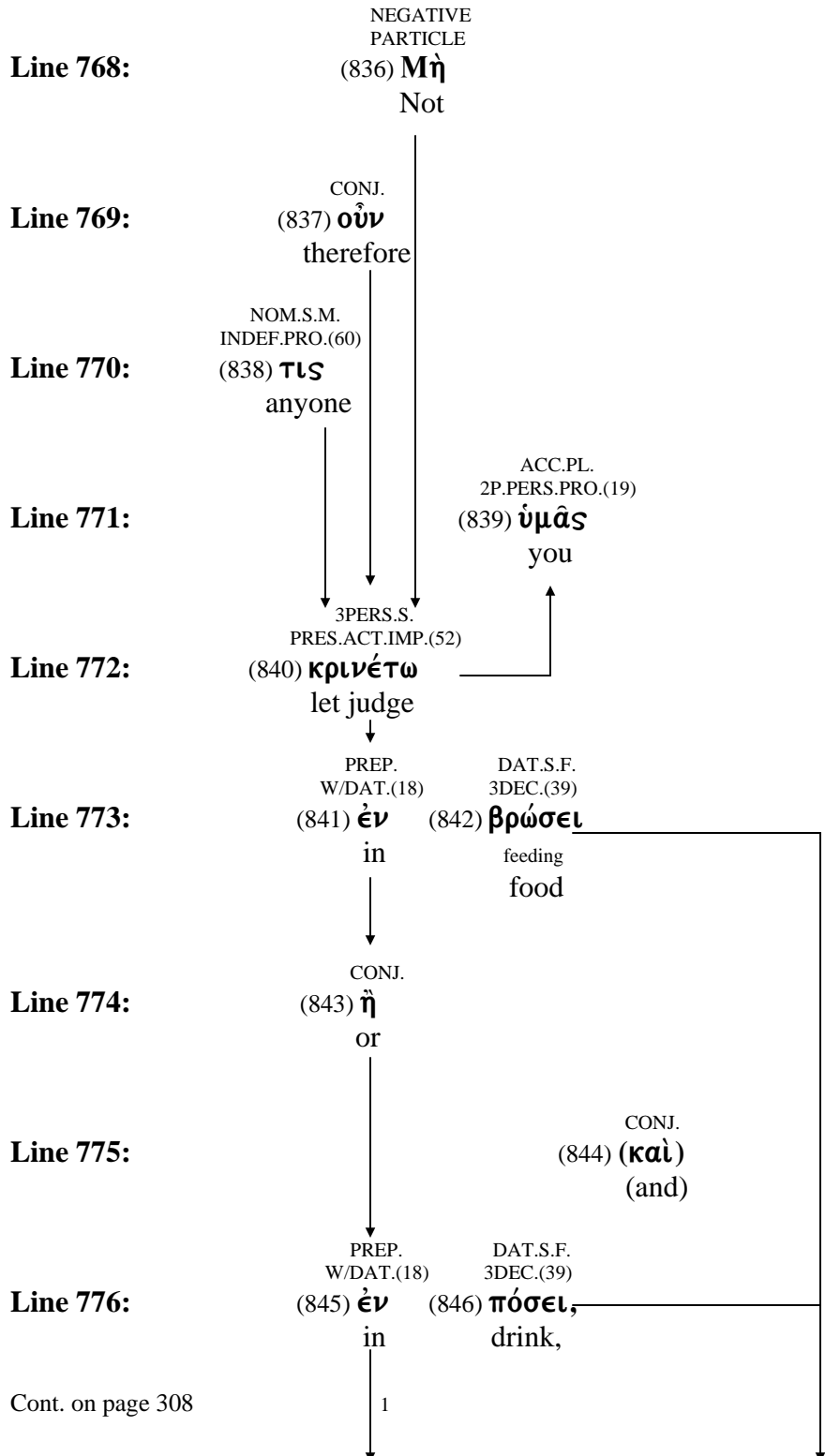

**Lesson Nine**  
**Colossians 2:16 Diagram**  
**Page 306**

**Colossians 2:16-19**  
**Verse 16 Word Study**

- (836) **μή** - negative particle = no, not
- (837) **οὖν** - particle = therefore, then
- (838) **τίς** - indefinite pronoun = a certain one, someone
- (839) **σύ** - second person personal pronoun = you
- (840) **κρίνω** = to judge, to determine; to separate
- (841) **ἐν**- preposition used with the dative = in
- (842) **βρῶσις** = the act of eating; food  
from **βιβρώσκω** = to eat
- (843) **ἢ** - particle used as a conjunction = or
- (844) **καί** - conjunction = and, also, even
- (845) **ἐν** - preposition used with the dative = in
- (846) **πόσις** = the act of drinking; a drink  
from **πίνω** = to drink

Continued on page 309.

**Colossians 2:16-19**  
**Verse 16 Diagram (continued)**

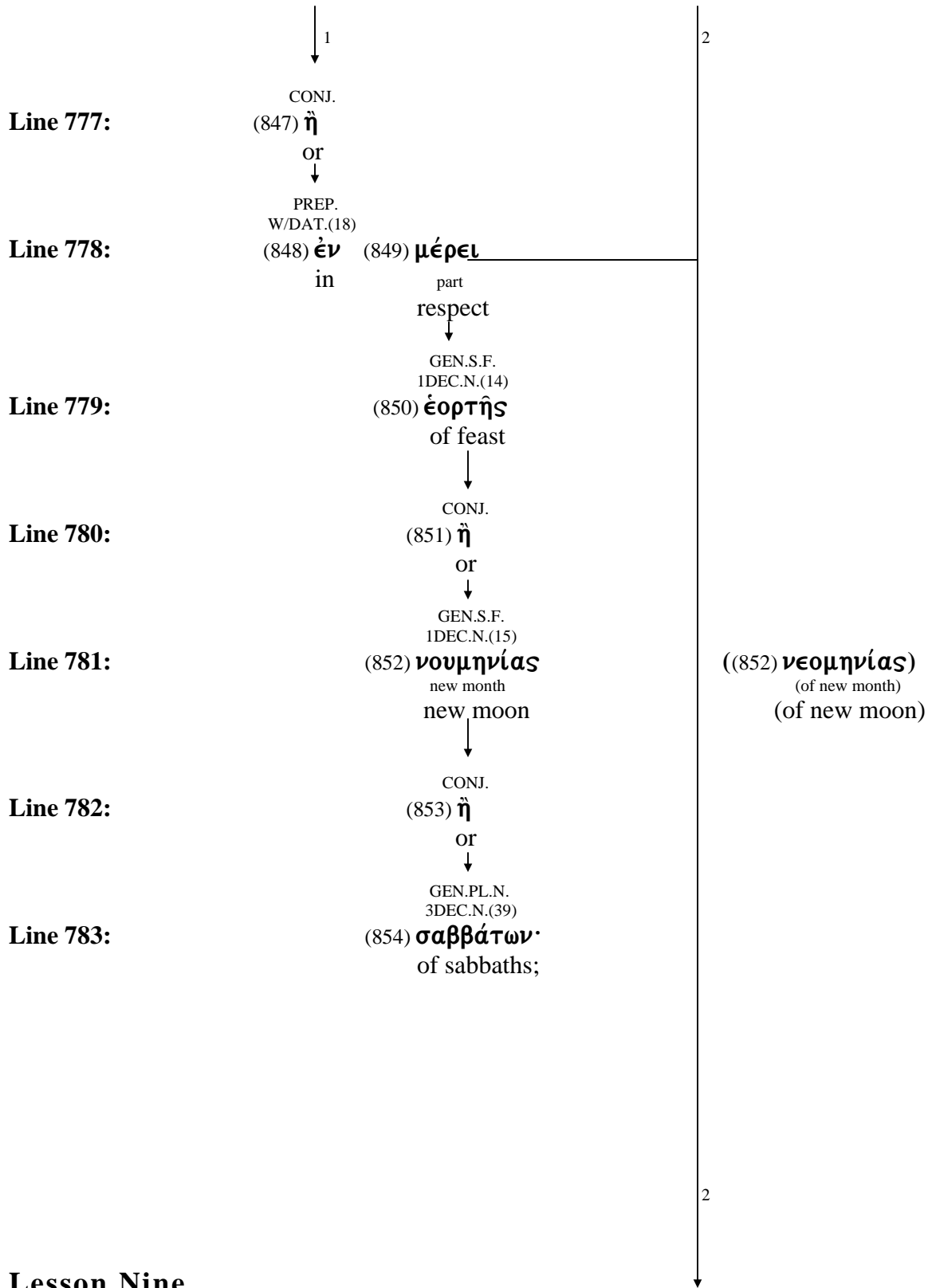

## Colossians 2:16-19

### Verse 16 Word Study (continued)

- (847) ἢ - particle used as a conjunction = or
- (848) ἐν - preposition used with the dative = in
- (849) μέρος = a part, a portion
- (850) ἑορτή = a feast day, a festival
- (851) ἢ - particle used as a conjunction = or
- (852) νεομηνία = new moon; the Jewish festival of the new moon  
from νέος - adjective = new, recent  
and μήν = month
- (853) ἢ - particle used as a conjunction = or
- (854) σάββατον = the Sabbath; seven days, a week.